

Mitigation of Rayleigh backscattering in RSOA-based WDM using MZI switching

UMESH GUPTA^{*}, RAJNEESH RANDHAWA^b HARBHAJAN SINGH^b

Research Scholar, IKG-PTU, Jalandhar & Faculty, MERI-CET, Haryana, India

^a*Punjabi University, Patiala, India*

^b*SSIET, PTU, Jalandhar, India*

We investigate the effects of Rayleigh backscattering in a RSOA-based WDM. The results show that the effects of Rayleigh-induced penalty on the gain of the RSOA and the lengths of drop fibers using MZI switching. In this paper, we propose and demonstrated a novel Rayleigh backscattering (RB) noise mitigation scheme based on MZI switching for wavelength division multiplexing. Reflective semiconductor optical amplifier (RSOA) are used in the WDM network for suppressing the mitigation and noise. With MZI switching, interference generated by carrier RB noise at low frequency region is eliminated successfully. Transmission performance for different parameters over 165 km universal fiber has been simulated and the optical-signal-to-Rayleigh-noise-ratio (OSRNR) can be reduced to 15 dB with MZI switching.

(Received August 13, 2014; accepted February 10, 2016)

Keywords: WDM Systems, Rayleigh Backscattering

1. Introduction

Recently, there have been many efforts to develop a long-reach wavelength-division-multiplex system (WDM) for minimise the non-linearity effects [1]. In such a long-reach WDM system, generally Erbium-doped fiber amplifier (EDFA) was often used to recompense for the losses of the transmission fiber. On the other hand, the most WDM system utilizing a low loss light sources (such as reflective semiconductor optical amplifiers (RSOAs)) is typically implemented in a simple configuration, in which the seed light and upstream signal operate at the same wavelength and travel in opposite directions within the same fiber [2]. Thus, the multipath interference (MPI), caused by the Rayleigh backscattering (RB) of the seed light and upstream signals, can result in the serious impairment of the transmission performance [3–5]. Previously, the effect of RB in a short-reach RSOA-based WDM system (in which no remote EDFA is used) has been discussed in [6, 7], including the dependence on the RSOA gain. However, this result cannot be applied to the long-reach WDM PON, since the RB signals generated in both the feeder and drop fibers are amplified by the remote EDFA and deteriorate the signal's quality. There are two kinds of RB noise in single fiber loop-back structure [6]. They are the carrier RB noise and the signal RB noise. Carrier RB noise is generated from beating between the upstream signal and the reflected downstream signal of the same wavelength. Since beating occurs at the baseband signal, carrier RB noise is located mainly at the low frequency region. Thus, carrier RB noise can be reduced by suppressing the low frequency portion of the upstream signal. Signal RB noise comes from the loop-back upstream signal which is modulated by the colorless ONU

again. Due to the re-modulation at the ONU, the signal RB noise has a wider electrical spectrum than carrier RB noise and the signal RB noise overlaps with the upstream data over the whole frequency band [7]. Various approaches have been demonstrated to effectively suppress carrier RB noise. For example, the use of destructive port in Mach-Zehnder delay interferometer (MZDI) for demodulating upstream differential phase-shift keying (DPSK) signal that results in 19 dB tolerance enhancement of carrier RB noise [8], utilizing electrical filtering effect (high-pass filter and DC-block) or proper signal coding format [9–11] such that low frequency interference is successfully suppressed and tolerance to signal-to-crosstalk ratio is enhanced. For signal RB noise mitigation, a high-gain non-linear semiconductor optical amplifier (NL-SOA) with low input saturation power has been used in loop-back ONU [12]. Meanwhile, many schemes focused on simultaneously mitigating signal and carrier RB noise, including using phase modulation for spectral broadening and wavelength shift amplitude-shift keying (ASK) modulation [13, 14], singlesideband carrier suppression scheme generated by a dual parallel Mach-Zehnder modulator (DP-MZM) in ONU [15,16], and four-wave mixing (FWM) effects [17,18].

2. Principle and system setup

In this paper, we investigate the effects of RB in a long-reach RSOA-based WDM PON operating at 40 Gb/s. In this network, we assume that a RSOA is used at Medium. The effects of non-linearity are classified into two types e.g. (BER or Q-factor) and calculate the RB-induced power penalties. We then simulated these

penalties as a function of the RSOA gain for various lengths of universal fibers. The simulated results show that the RB induced penalty is dependent on the RSOA gain and there is an optimum RSOA gain to minimize this penalty. However, since the optimum RSOAA gain depends highly on the length of the drop fiber, it is almost impossible to accommodate various lengths of drop fibers simultaneously (even if we assume that the RSOA gain is adjustable). As a result, the design of long-reach WDM system can be seriously restricted by the MPI noise resulting from RB. To mitigate this problem, we examine the possibility of using an additional booster depending on the length of the drop fiber.

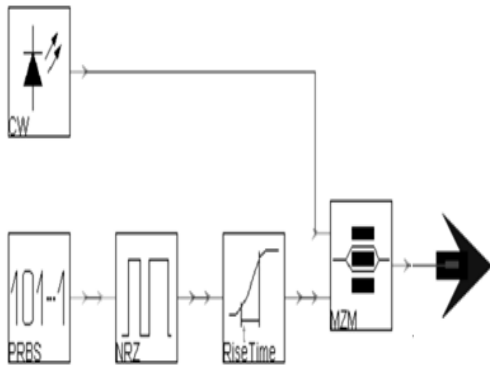

Fig. 1. A Simple Transmitter Section

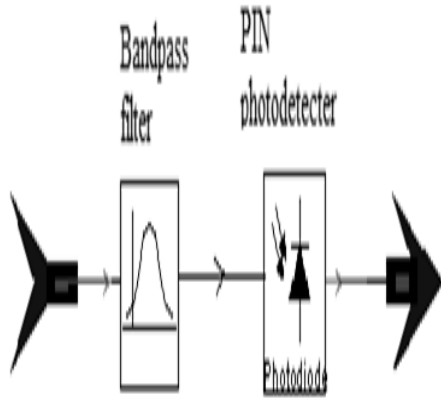

Fig. 2. A Simple Reciever Section

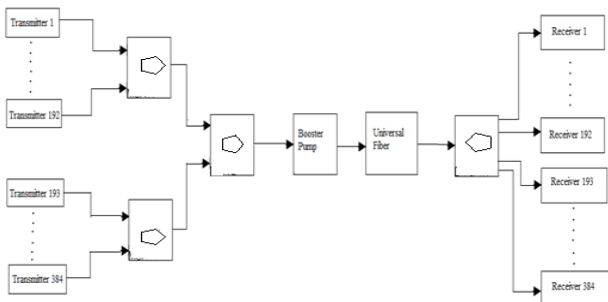

Fig. 3. Setup for 2X192 users with booster properties for recovering non-linearity properties

3. Experiments and results

The above setup comprises with 384 transmitters (for each user) multiplexed by 1:192 multiplexer followed again 2:1 multiplexer by RSOA amplifier which serves as booster to compensate the various non-linear losses. Various described results detailed below shows the effect of RSOA on the mitigation and dispersion compensation of universal fiber for various lengths.

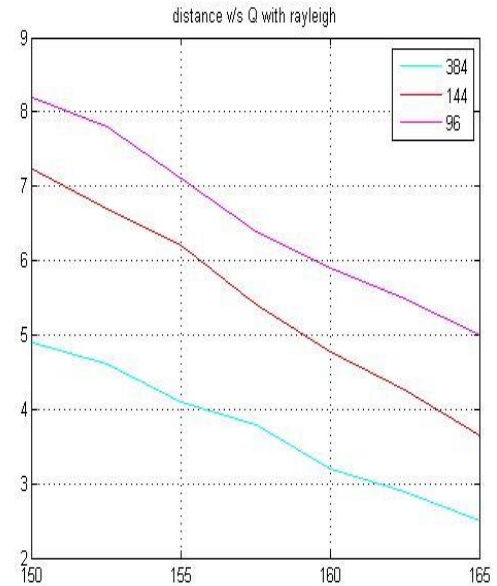
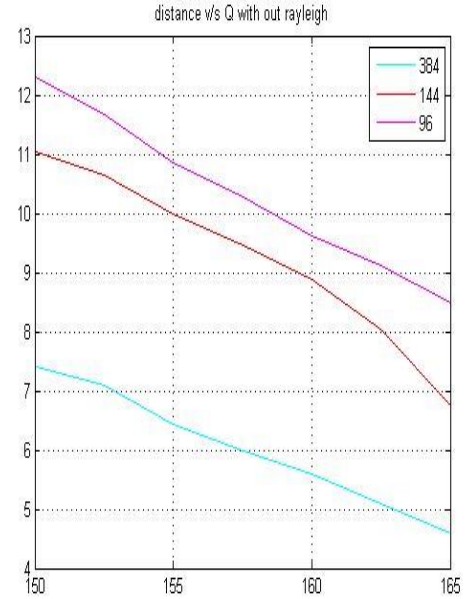

Fig. 4. Q factor versus distance for various channels with RSOA and without RSOA

Above results showed that q factor for different channels without booster i.e. RSOA dropped sharply as distance increases for various channels e.g. (96, 144, 384) while we using proposed setup then q factor dropped

gradually as shown in the graph with increasing the distance.

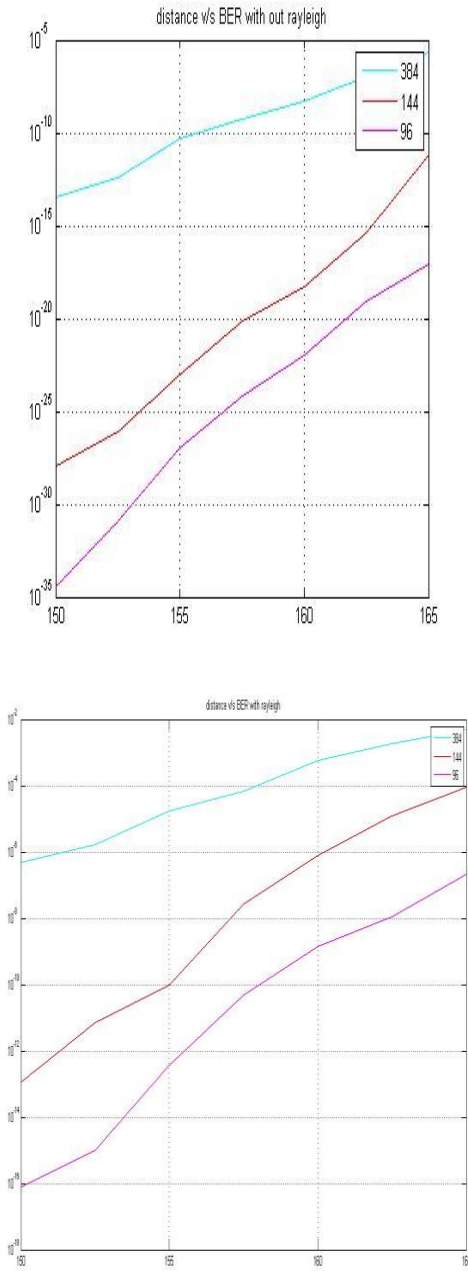

Fig. 5. BER vs distance for various channels in same configuration

Further, BER is also played an important role in defining the non-linearity of optical fiber for various lengths in swing with different channels. As distance increase for the channels e.g. (96, 144, 384) the BER increase sharply in case of previous setup that comprises without RSOA. If we began with proposed setup, then the BER increase very gradually as shown in the above Fig. 5.

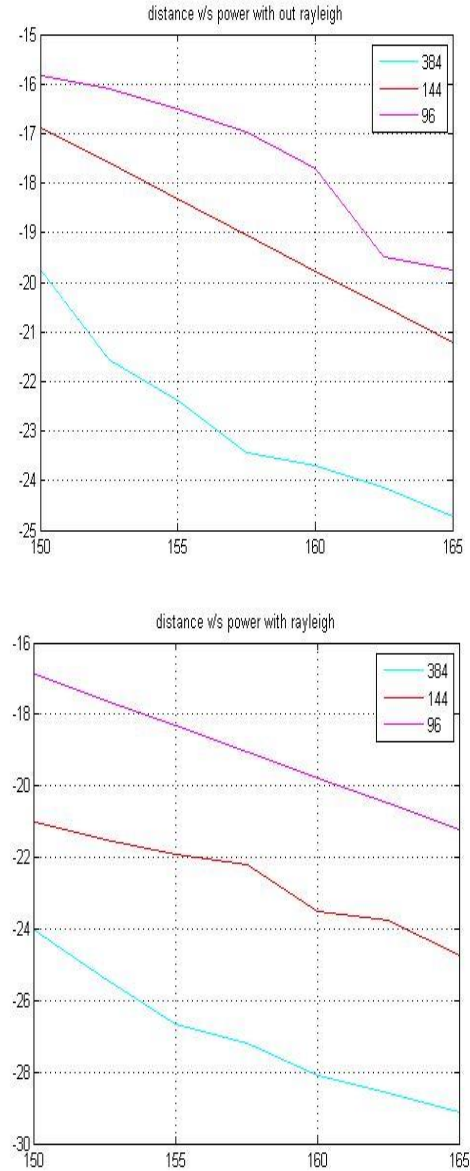

Fig. 6. OSNR vs distance for various channels in same configuration

As we already discussed the effects of non-linear losses on the power of the receiver side, and the sensitivity can also be handled with improving the OSNR. Result (fig 6) revealed that OSNR without booster or RSOA is showing non-linearity for 96 channels while in case of RSOA it shows a linear graph and, eventually RSOA increases the power upto 10 dbm. It can be a better choice for WDM system which comprises a MZI switching

4. Conclusion

In this paper, we have investigated effects of Rayleigh noise performance by realizing MZI switching using RSOA. Our scheme is easy to realize and is suitable for enhancing loop-back WDM-PON. The MZM used for

generating multi-subcarrier source, microwave source, and multiplexer in the system can be shared by all subscribers to reduce system cost. The proposed MZI switching scheme is based on gain saturation effect in RSOA, which is stable and immune to bias voltage drift – more tolerate to environment changes. Compared with using CW light as the seeding light, RB noise tolerance is improved with the use of a multi-subcarrier light. Interference between the carrier RB noise and the upstream signal at low frequency region is mitigated successfully by central carrier suppression. Results show that is achieved with -10 dBm input optical power and the OSRNR is reduced to 10 dB. Improvement in OSRNR is resulted from an increase in MZI switching. BER performance is improved by 6 dB with the use of a microwave photonic filter in OLT, which suppresses residual microwave signal and residual RB noise at the high frequency region.

References

- [1] R. P. Davey et al., *IEEE JLT*, **27**(3), 273 (2009).
- [2] K. Y. Cho et al., *IEEE JLT*, **27**(10), 1286 (2009).
- [3] P. Wan et al., *IEEE JLT*, **14**(3), 288 (2001).
- [4] P. J. Legg et al., *IEEE JLT*, **14**(9), 1943 (1996).
- [5] E. L. Goldstein et al., *IEEE PTL*, **6**(5), 657 (1994)
- [6] C. W. Chow, C. H. Yeh, L. Xu, H. K. Tsang, *IEEE Photon. Technol. Lett.* **22**(17), 1294 (2010).
- [7] C. W. Chow, G. Talli, A. D. Ellis, P. D. Townsend, *Opt. Express* **16**(3), 1860 (2008).
- [8] Jing Xu, Ming Li, Lian-Kuan Chen, *J. Lightwave Technol.* **29**(24), 3632 (2011).
- [9] A. Chiuchiarelli, M. Presi, R. Proietti, G. Contestabile, P. Choudhury, L. Giorgi, E. Ciaramella, *IEEE Photon. Technol. Lett.* **22**(2), 85 (2010).
- [10] L. Zhixin, X. Jing, W. Qike, C. Chun-Kit, in *Optical Fiber Communication Conference (OFC)*, 2012, 1–3.
- [11] C. F. Marki, F. A. Marki, S. C. Esener, *Electron. Lett.* **43**(11), 644 (2007).
- [12] E. K. MacHale, G. Talli, C. W. Chow, P. D. Townsend, in *European Conference and Exhibition of Optical Communication (ECOC)*, 2007, 1–2.
- [13] C. W. Chow, G. Talli, P. D. Townsend, *IEEE Photon. Technol. Lett.* **19**(6), 423 (2007).
- [14] C. W. Chow, C. H. Yeh, *IEEE Photon. J.* **5**(2), 7900407 (2013).
- [15] C. H. Wang, C. W. Chow, C. H. Yeh, C. L. Wu, S. Chi, C. Lin, *IEEE Photon. Technol. Lett.* **22**(11), 820 (2010).
- [16] C. W. Chow, C. H. Yeh, *Opt. Express* **19**(6), 4970 (2011).
- [17] B. Schrenk, G. de Valicourt, J. A. Lazaro, R. Brenot, J. Prat, *J. Lightwave Technol.* **28**, 3364 (2010).
- [18] B. Schrenk, J. A. Lazaro, J. Prat, in *Optical Fiber Communication Conference (OFC)*, 2010, 1–3.

*Corresponding author: umeshguptaece@gmail.com